

Separatori
applicabili ai canali
con guide.
Separators
for wire ducts with rails.

Coperchio
con inserimento a scatto.
Snap-on cover

Forature
per il fissaggio a parete con tasselli.
Holes
For wall mounting with plugs.

Fori pretranciati
Per derivare tubi rigidi e corrugati.
Pre-punched holes
To connect pipes and hoses.

AS Canali per ascensori

Trunking for lifts

CE A Norme
EN-50085-2-1

Canale portacavi.
Wiring ducts.



PAGINA / PAGE

17

CE A Norme
EN-50085-2-1

Canale per derivare tubi rigidi e corrugati.
Trunking to connect pipes and hoses.



PAGINA / PAGE

17

CE A Norme
EN-50085-2-1

Canale speciale pretranciato.
Special pre-punched trunking.



PAGINA / PAGE

17

Codifica per l'ordine dei canali Functional part numbering system	
Tipo / Type	
AS	G8P

DISPOSIZIONE FORI SUL FONDO / SIZES AND LAYOUT OF HOLES ON THE BOTTOM

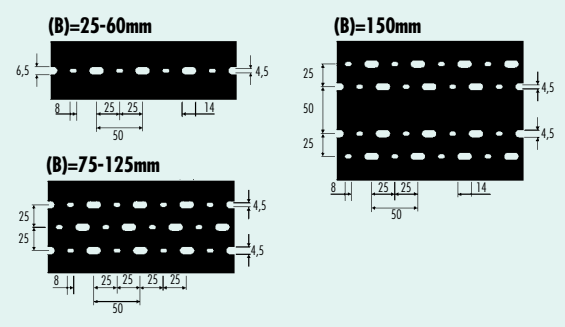

DATI TECNICI / TECHNICAL DATA

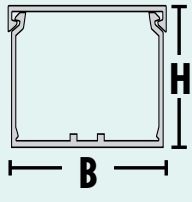

- I canali vengono forniti completi di coperchio.
- All trunkings come complete with cover.

AS Canali per ascensori* Trunking for lifts

*FORNIBILE A RICHIESTA E PER QUANTITÀ DA CONCORDARE. / ON REQUEST AND FOR QUANTITIES TO BE AGREED.

G

Canali portacavi.

Materiale: PVC Rigido Autoestinguente Classe 1 (UL94-VO). Lunghezza: 2 metri

Wiring ducts.







Self-extinguishing rigid PVC Class 1 (UL94-VO). Length: 2 meters



COLORI / COLOURS

 G = Grigio / Grey

Vedi accessori pag. 32 / See accessories page 32

EAN	Sezione fondo	Tipo	B mm	H mm	Imballo m	Imballo m ³	Cartone peso Kg	S. G. mm ²
EAN Code	Section of the bottom	Type	B mm	H mm	Standard Carton m	Packing m ³	Carton Weight Kg	G. S. mm ²
031674		AS G8	40	40	40	0,057	16,0	1310
031643		AS G4	60	40	24	0,051	13,0	1960
031698		AS G9		60	24	0,069	18,0	3080
031735		AS G26	80	40	24	0,069	15,8	2665
031667		AS G6		60	24	0,092	22,0	4175
031612		AS G17	100	60	20	0,092	21,0	5295
031629		AS G19		80	16	0,092	21,2	7215
031605		AS G10	120	60	16	0,085	19,3	6390
031636		AS G32		80	16	0,106	23,1	8710
031711		AS G33	150	80	12	0,106	21,2	10770

G/P

Canale per derivare tubi rigidi e corrugati.

Materiale: PVC Rigido Autoestinguente Classe 1 (UL94-VO). Lunghezza: 2 metri

Trunking to connect pipes and hoses.



Self-extinguishing rigid PVC Class 1 (UL94-VO). Length: 2 meters



COLORI / COLOURS

 G = Grigio / Grey

Vedi accessori pag. 32 / See accessories page 32

EAN	Sezione fondo	Tipo	B mm	H mm	Imballo m	Imballo m ³	Cartone peso Kg	S. G. mm ²
EAN Code	Section of the bottom	Type	B mm	H mm	Standard Carton m	Packing m ³	Carton Weight Kg	G. S. mm ²
031681		AS G8P	40	40	40	0,057	16,0	1310
031650		AS G4P	60	40	24	0,051	12,9	1960
031728		AS G26P	80	40	24	0,069	15,4	2665

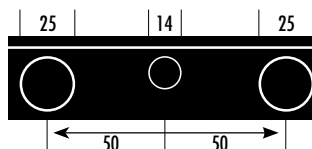

G/P

Canale speciale pretranciato.

Materiale: PVC Rigido Autoestinguente Classe 1 (UL94-VO). Lunghezza: 2 metri

Special pre-punched trunking.



Self-extinguishing rigid PVC Class 1 (UL94-VO). Length: 2 meters



COLORI / COLOURS

 G = Grigio / Grey

Vedi accessori pag. 32 / See accessories page 32

EAN	Sezione fondo	Tipo	B mm	H mm	Imballo m	Imballo m ³	Cartone peso Kg	S. G. mm ²
EAN Code	Section of the bottom	Type	B mm	H mm	Standard Carton m	Packing m ³	Carton Weight Kg	G. S. mm ²
031568		G055P	50	50	24	0,051	12,7	2126
031575		G075P	75	50	24	0,069	16,3	3115
031551		G105P	100	50	16	0,064	14,6	4270

